



Driver LCO 90W 200–1050mA 165V pD+ NFC C PRE3 premium NFC outdoor series

Product description

- Dimmable built-in constant current LED Driver
- Dimming range 1 – 100 % (min. 10 mA)
- For luminaires of protection class I and protection class II
- Temperature protection as per EN 61347-2-13 C5e
- Output current adjustable between 200 – 1,050 mA via NFC, DALI or ready2mains™ Programmer
- Max. output power 90 W
- Up to 92 % efficiency
- Lowest power input on stand-by < 0.3 W
- Nominal life-time of 100,000 h and 8-year guarantee



Interfaces

- Near field communication (NFC)
- Powered DALI-2, min. current supply 55 mA
- ready2mains™ (configuration via mains)
- U6Me2 (configuration of chronoSTEP 2 via mains and ready2mains Programmer)
- Terminal blocks: 45° push terminals

Functions

- Adjustable output current in 1-mA-steps (NFC, DALI, ready2mains™)
- Programmable chronoSTEP: times and levels (NFC, DALI, U6Me2, ready2mains™)
- Enhanced constant light output function (eCLO)
- Protective features (overtemperature, short-circuit, overload, no-load, input voltage range, reduced surge amplification)
- Intelligent Temperature Guard (ITG)
- Intelligent Voltage Guard Plus (IVG+)
- External Temperature Management (ETM)
- Auxiliary 24 V, 3 W power supply
- DiiA/Zhaga connectivity extensions DT49, DT50, DT51, DT52
- deviceKEY against unauthorized change of parameters

Benefits

- Flexible configuration via companionSUITE (NFC, DALI, ready2mains™) or U6Me2 programmer
- Best energy savings due to low stand-by losses and high efficiency
- In-field programming possible after installation with NFC interface or ready2mains
- High overvoltage protection: up to 10 kV asymmetric (protection class I and II)

Typical applications

- Road, street and industry





Driver LCO 90W 200–1050mA 165V pD+ NFC C PRE3 premium NFC outdoor series

Technical data

Rated supply voltage	220 – 240 V
AC voltage range	198 – 264 V
DC voltage range	176 – 280 V
Mains frequency	0 / 50 / 60 Hz
Overvoltage protection	320 V AC, 48 h
Typ. current (at 230 V, 50 Hz, full load) ^① ②	438 mA
Typ. current (220 V, 0 Hz, full load, 15 % dimming level) ^②	85 mA
Leakage current (at 230 V, 50 Hz, full load) ^① ②	< 500 µA
Max. input power	100 W
Typ. efficiency (at 230 V / 50 Hz / full load) ^② ③	92 %
λ (at 230 V, 50 Hz, full load) ^①	0.98
Typ. power input on stand-by ^③	< 0.3 W
In-rush current (peak / duration)	38 A / 280 µs
THD (at 230 V, 50 Hz, full load) ^①	< 8 %
Starting time (AC mode)	< 750 ms
Starting time (DC mode)	< 800 ms
Switchover time (AC/DC)	< 300 ms
Turn off time (at 230 V, 50 Hz, full load)	< 500 ms
Output current tolerance ^① ④	± 3 %
Max. peak output current (non-repetitive)	≤ output current + 15 %
Output LF current ripple (< 120 Hz)	± 4 %
Output P _{st} LM	≤ 1
Output SVM	≤ 0.4
Max. output voltage (HV)	220 V
Max. output voltage (LV)	130 V
Dimming range	1 – 100 % (min. 10 mA)
Mains surge capability (between L – N) ^⑤	6 kV / 3 kA
Mains surge capability (between L/N – PE)	10 kV
Burst protection	6 kV
Surge voltage at output side (against PE)	< 1 kV
Type of protection	IP20
Dimensions L x W x H	150 x 90 x 37.5 mm

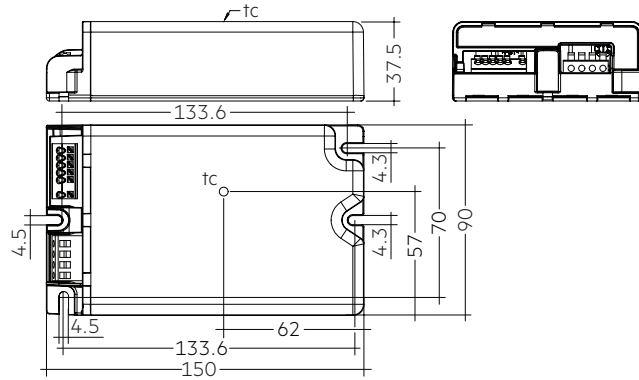

Ordering data

Type	Article number	Packaging carton	Packaging pallet	Weight per pc.
LCO 90/200-1050/165 pD+ NF C PRE3	87500832	10 pc(s).	150 pc(s).	0.739 kg

Specific technical data

Type	Output current ^②	Min. forward voltage	Max. forward voltage	Max. output power	Typ. power consumption (at 230 V, 50 Hz, full load)	Typ. current consumption (at 230 V, 50 Hz, full load)	Max. casing temperature t _c	Ambient temperature t _a max.
High voltage output (HV)								
LCO 90/200-1050/165 pD+ NF C PRE3	200 mA	78.0 V	165.0 V	33.0 W	39.5 W	182 mA	85 °C	-40 ... +70 °C
	250 mA	78.0 V	165.0 V	41.3 W	48.2 W	218 mA	85 °C	-40 ... +70 °C
	300 mA	78.0 V	165.0 V	49.5 W	56.7 W	254 mA	85 °C	-40 ... +65 °C
	350 mA	78.0 V	165.0 V	57.8 W	65.2 W	290 mA	85 °C	-40 ... +65 °C
	400 mA	78.0 V	165.0 V	66.0 W	73.7 W	327 mA	85 °C	-40 ... +65 °C
	450 mA	78.0 V	165.0 V	74.3 W	82.4 W	364 mA	85 °C	-40 ... +65 °C
	500 mA	78.0 V	165.0 V	82.5 W	91.2 W	403 mA	85 °C	-40 ... +60 °C
	550 mA	78.0 V	163.6 V	90.0 W	99.2 W	437 mA	85 °C	-40 ... +60 °C
	600 mA	78.0 V	150.0 V	90.0 W	98.7 W	434 mA	85 °C	-40 ... +60 °C
	650 mA	78.0 V	138.5 V	90.0 W	98.1 W	432 mA	85 °C	-40 ... +65 °C
	700 mA	78.0 V	128.6 V	90.0 W	98.0 W	431 mA	85 °C	-40 ... +65 °C
	750 mA	78.0 V	120.0 V	90.0 W	97.9 W	431 mA	85 °C	-40 ... +65 °C
	800 mA	78.0 V	112.5 V	90.0 W	97.7 W	430 mA	85 °C	-40 ... +65 °C
	850 mA	78.0 V	105.9 V	90.0 W	97.6 W	430 mA	85 °C	-40 ... +65 °C
	900 mA	78.0 V	100.0 V	90.0 W	97.7 W	430 mA	85 °C	-40 ... +65 °C
	950 mA	78.0 V	94.7 V	90.0 W	97.5 W	429 mA	85 °C	-40 ... +65 °C
	1,000 mA	78.0 V	90.0 V	90.0 W	97.7 W	430 mA	85 °C	-40 ... +65 °C
	1,050 mA	78.0 V	85.7 V	90.0 W	97.3 W	429 mA	85 °C	-40 ... +65 °C
Low voltage output (LV)								
LCO 90/200-1050/165 pD+ NF C PRE3	200 mA	72.0 V	97.0 V	19.4 W	25.6 W	125 mA	85 °C	-40 ... +70 °C
	250 mA	57.6 V	97.0 V	24.3 W	30.7 W	146 mA	85 °C	-40 ... +70 °C
	300 mA	48.0 V	97.0 V	29.1 W	35.8 W	166 mA	85 °C	-40 ... +70 °C
	350 mA	46.0 V	97.0 V	34.0 W	40.9 W	187 mA	85 °C	-40 ... +70 °C
	400 mA	46.0 V	97.0 V	38.8 W	46.0 W	208 mA	85 °C	-40 ... +65 °C
	450 mA	46.0 V	97.0 V	43.7 W	51.0 W	230 mA	85 °C	-40 ... +65 °C
	500 mA	46.0 V	97.0 V	48.5 W	56.0 W	251 mA	85 °C	-40 ... +65 °C
	550 mA	46.0 V	97.0 V	53.4 W	61.2 W	273 mA	85 °C	-40 ... +65 °C
	600 mA	46.0 V	97.0 V	58.2 W	66.2 W	295 mA	85 °C	-40 ... +65 °C
	650 mA	46.0 V	97.0 V	63.1 W	71.2 W	316 mA	85 °C	-40 ... +65 °C
	700 mA	46.0 V	97.0 V	67.9 W	76.2 W	338 mA	85 °C	-40 ... +65 °C
	750 mA	46.0 V	97.0 V	72.8 W	81.4 W	360 mA	85 °C	-40 ... +60 °C
	800 mA	46.0 V	97.0 V	77.6 W	86.6 W	382 mA	85 °C	-40 ... +60 °C
	850 mA	46.0 V	97.0 V	82.5 W	91.7 W	404 mA	85 °C	-40 ... +60 °C
	900 mA	46.0 V	97.0 V	87.3 W	96.8 W	426 mA	85 °C	-40 ... +60 °C
	950 mA	46.0 V	94.7 V	90.0 W	99.5 W	438 mA	85 °C	-40 ... +60 °C
	1,000 mA	46.0 V	90.0 V	90.0 W	99.4 W	437 mA	85 °C	-40 ... +60 °C
	1,050 mA	46.0 V	85.7 V	90.0 W	99.1 W	436 mA	85 °C	-40 ... +60 °C

① Valid at 100 % dimming level.

② Depending on the selected output current.

③ 24 V AUX no load, pDALI off. Depending on the power supply at the DALI interface.

④ L-N acc. to EN 61000-4-5. 2 Ohm, 12/50 µs, 8/20 µs.

⑤ Output current is mean value.

⑥ Tolerance range ±5 %.

1. Standards

EN 55015
 EN 61000-3-2
 EN 61000-3-3
 EN 61000-4-4
 EN 61000-4-5
 EN 61347-1
 EN 61347-2-13
 EN 62384
 EN 61547
 EN 62386-101 (DALI-2)
 EN 62386-102 (DALI-2)
 EN 62386-207 (DALI-2)
 According to EN 50172 for use in central battery systems
 According to EN 60598-2-22 suitable for emergency luminaire

1.1 Glow wire test

according to EN 61347-1 with increased temperature of 850 °C passed.

2. Thermal details and life-time

2.1 Expected life-time

Expected life-time HV

Type	Output current	ta	40 °C	45 °C	50 °C	55 °C	60 °C	65 °C	70 °C
LCO 90/200-1050/165 pD+ NF C PRE3	200 – 250 mA	tc	55 °C	60 °C	65 °C	70 °C	75 °C	80 °C	85 °C
		Life-time	> 100,000 h	> 100,000 h	> 100,000 h	> 100,000 h	> 100,000 h	> 100,000 h	> 100,000 h
	>250 – 450 mA	tc	60 °C	65 °C	70 °C	75 °C	80 °C	85 °C	–
		Life-time	> 100,000 h	> 100,000 h	> 100,000 h	> 100,000 h	> 100,000 h	80,000 h	–
	>450 – 600 mA	tc	65 °C	70 °C	75 °C	80 °C	85 °C	–	–
		Life-time	> 100,000 h	> 100,000 h	> 100,000 h	> 100,000 h	70,000 h	–	–
	>600 – 1,050 mA	tc	60 °C	65 °C	70 °C	75 °C	80 °C	85 °C	–
		Life-time	> 100,000 h	> 100,000 h	> 100,000 h	> 100,000 h	> 100,000 h	65,000 h	–

Expected life-time LV

Type	Output current	ta	40 °C	45 °C	50 °C	55 °C	60 °C	65 °C	70 °C
LCO 90/200-1050/165 pD+ NF C PRE3	200 – 350 mA	tc	55 °C	60 °C	65 °C	70 °C	75 °C	80 °C	85 °C
		Life-time	> 100,000 h	> 100,000 h	> 100,000 h	> 100,000 h	> 100,000 h	> 100,000 h	> 100,000 h
	>350 – 700 mA	tc	60 °C	65 °C	70 °C	75 °C	80 °C	85 °C	–
		Life-time	> 100,000 h	> 100,000 h	> 100,000 h	> 100,000 h	> 100,000 h	80,000 h	–
>700 – 1,050 mA	tc	65 °C	70 °C	75 °C	80 °C	85 °C	–	–	
	Life-time	> 100,000 h	> 100,000 h	> 100,000 h	> 100,000 h	75,000 h	–	–	

The LED Driver is designed for a life-time stated above under reference conditions and with a failure probability of less than 10 %.

The relation of tc to ta temperature depends also on the luminaire design.

If the measured tc temperature is approx. 5 K below tc max., ta temperature should be checked and eventually critical components (e.g. ELCAP) measured. Detailed information on request.

3. Installation / wiring

3.1 Circuit diagram

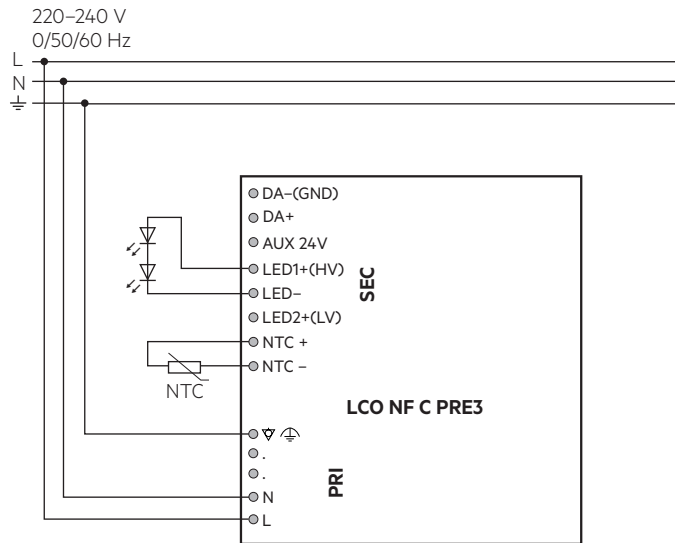

For wiring in dimming operation with ready2mains refer to the ready2mains Gateway data sheet.

3.2 Wiring type and cross section

Input side:

Solid wire with a cross section of 0.5 – 2.5 mm². Strip 10 – 11 mm of insulation from the cables to ensure perfect operation of terminals.

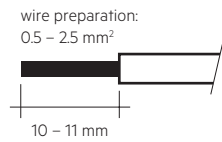

Output side:

Solid wire with a cross section of 0.2 – 1.5 mm². Strip 8.5 – 9.5 mm of insulation from the cables to ensure perfect operation of terminals.

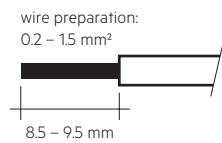

NTC terminal:

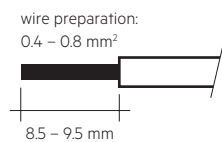

3.3 Wiring guidelines

- Run the secondary lines separately from the mains connections and lines to achieve good EMC performance.
- The max. secondary cable length is 2 m (4 m circuit).
- For good EMC performance, keep the LED wiring as short as possible.
- Secondary switching is not permitted.
- The LED Driver has no inverse-polarity protection on the secondary side. Wrong polarity can damage LED modules with no inverse-polarity protection.
- Wrong wiring of the LED Driver can lead to malfunction or irreparable damage.
- To enhance the capability against mechanical stress (vibration), it is recommended to apply washers for the screws in installation.
- To avoid the damage of the Driver, the wiring must be protected against short circuits to earth (sharp edged metal parts, metal cable clips, louver, etc.).

3.4 Hot plug-in

Hot plug-in is not supported due to residual output voltage of > 0 V. If a LED load is connected, the device has to be restarted before the output will be activated again. This can be done via mains reset or via interface (DALI, DSI, ready2mains).

3.5 Earth connection

The earth connection is conducted as function earth (FE). There is no earth connection required for the functionality of the LED Driver. Earth connection is recommended to improve following behaviour:

- Electromagnetic interferences (EMI)
- LED glowing at standby
- Transmission of mains transients to the LED output

4. Electrical values

4.1 Operating window

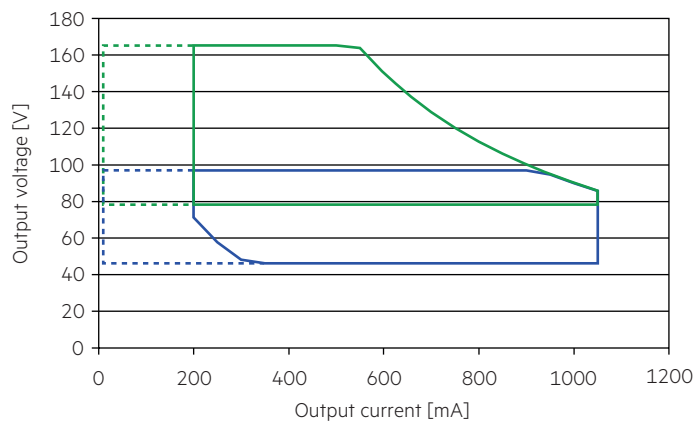

- Operating window 100 % (high output voltage)
- - - Operating window dimmed (high output voltage)
- Operating window 100 % (low output voltage)
- - - Operating window dimmed (low output voltage)

Make sure that the LED Driver is operated within the given window under all operating conditions. Special attention needs to be paid at dimming and DC emergency operation as the forward voltage of the connected LED modules varies with the dimming level, due to the implemented amplitude dimming technology. Coming below the specified minimum output voltage of the LED Driver may cause the device to shut-down.

See chapter "6.5 Light level in DC operation" for more information.

4.2 Efficiency vs load (HV)

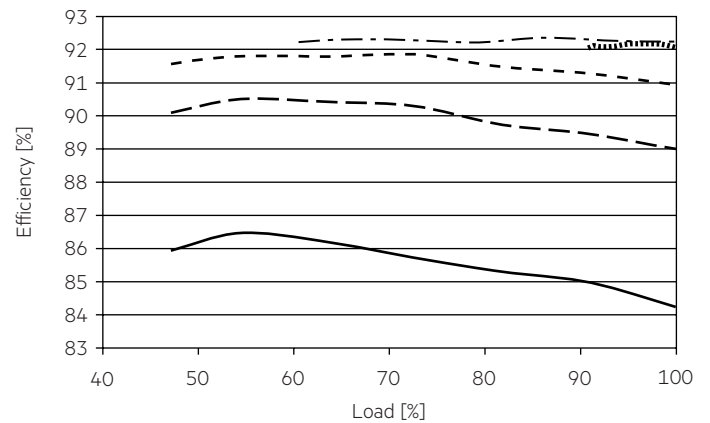

4.3 Power factor vs load (HV)

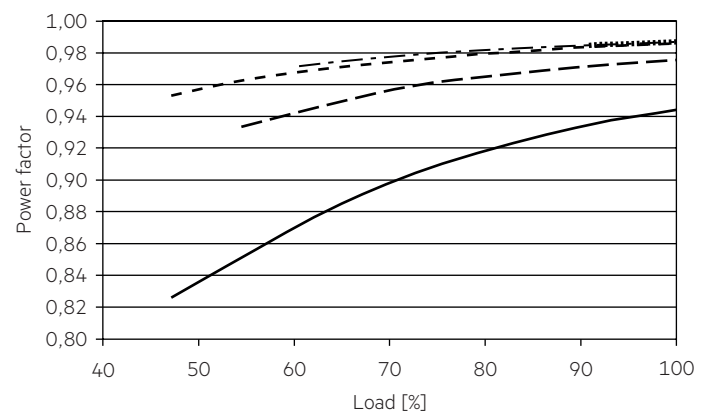

4.4 THD vs load (HV)

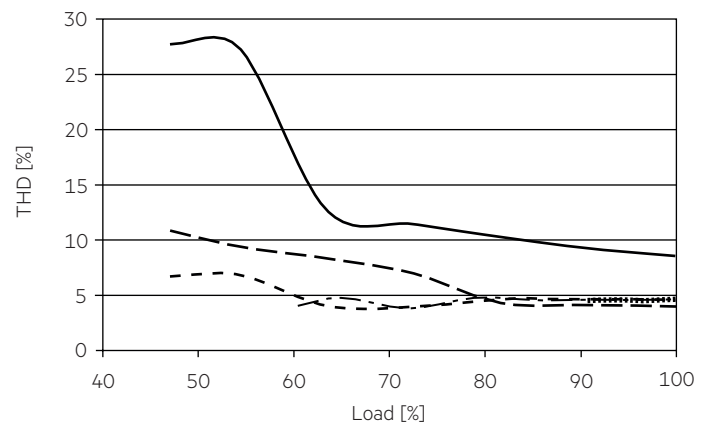

- 200 mA
- - - 350 mA
- - - 500 mA
- - - 700 mA
- 1050 mA

4.5 Efficiency vs load (LV)

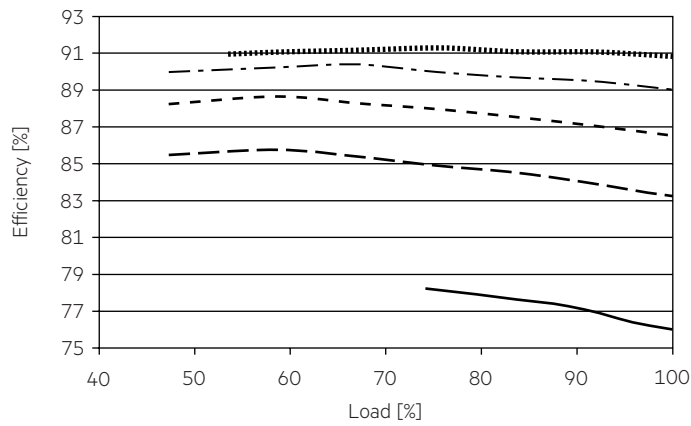

4.7 THD vs load (LV)

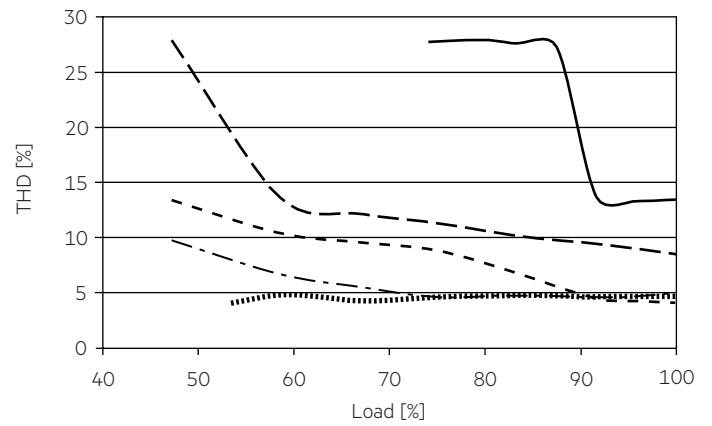

4.6 Power factor vs load (LV)

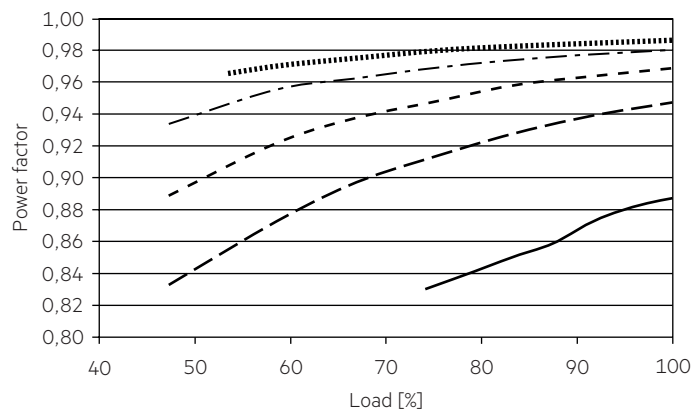

- 200 mA
- - - 350 mA
- - - 500 mA
- - - 700 mA
- 1050 mA

100 % load corresponds to the max. output power (full load) according to the table on page 3.

4.8 Maximum loading of automatic circuit breakers in relation to inrush current

Automatic circuit breaker type	C10	C13	C16	C20	B10	B13	B16	B20	Inrush current	
Installation Ø	1.5 mm ²	1.5 mm ²	2.5 mm ²	4 mm ²	1.5 mm ²	1.5 mm ²	2.5 mm ²	4 mm ²	I _{max}	time
LCO 90/200-1050/165 pD+ NF C PRE3	10	13	16	21	6	8	10	13	38 A	280 µs

This are max. values calculated out of inrush current! Please consider not to exceed the maximum rated continuous current of the circuit breaker. Calculation uses typical values from ABB series S200 as a reference. Actual values may differ due to used circuit breaker types and installation environment.

4.9 Harmonic distortion in the mains supply (at 230 V / 50 Hz and full load) in %

	THD	3.	5.	7.	9.	11.
LCO 90/200-1050/165 pD+ NF C PRE3	< 8	< 8	< 3	< 3	< 2	< 2

5. Software / Programming / Interfaces

5.1 Software / programming

With appropriate software and interface different functions can be activated and various parameters can be configured in the LED Driver. The Driver supports the following software and interfaces:

Software / hardware for configuration:

- companionSUITE (deviceGENERATOR, deviceCONFIGURATOR, deviceANALYSER)
- masterCONFIGURATOR
- ready2mains Programmer

Interfaces for data transfer:

- NFC
- Control input DALI
- Control input ready2mains
- U6Me2

5.2 Nearfield communication (NFC)

The NFC Interface allows wireless communication with the LED Driver. This interface offers the option to write configuration and to read configuration, errors and events with the companionSUITE. A correct communication between the LED Driver and the NFC antenna can only be guaranteed if the antenna is placed directly on the Driver. Any material placed between the LED Driver and the NFC antenna can cause a deterioration of the communication quality. After programming the device via NFC power up the device one time for one second till the deviceANALYSER can read out the parameters. We recommend the use of following NFC antenna:
www.tridonic.com/nfc-readers

NFC is complied with ISO/IEC 15963 standard.

5.3 Control input DALI

The control input is non-polar for digital control signals (DALI). The control signal is not SELV. The control cable has to be installed in accordance to the requirements of low voltage installations.

Digital control with:

- DALI signal: 16 bit

Dimming is realized by amplitude dimming.

5.4 Control input ready2mains (L, N)

The digital ready2mains protocol is modulated onto the mains signal which is wired to the mains terminal (L and N).

The configuration is done via the ready2mains Programmer, either directly at the Programmer itself or via a respective software tool. For details on the configuration via ready2mains see the technical information of the Programmer and its tools.

Following tools can be used:

- deviceCONFIGURATOR (companionSUITE)
- masterCONFIGURATOR
- ready2mains Programmer

5.5 U6Me2

Settings of chronoSTEP function could be done via switching mains commands. For detailed description for timings and intervals see product manual.

Key features:

- Auto-dimming with 8 sequences
- Every sequence can hold 8 parameter pairs
- Separate dim-level for each time parameter
- Various commands + parameter for extensions
- Output current setting for each channel individual

6. Functions

 companionSUITE:
DALI-USB, ready2mains Programmer, NFC
The companionSUITE with deviceGENERATOR, deviceCONFIGURATOR and deviceANALYSER is available via our WEB page:
<https://www.tridonic.com/com/en/products/companionsuite.asp>

 masterCONFIGURATOR:
DALI-USB, ready2mains Programmer (in DALI mode)
The masterCONFIGURATOR is available via our WEB page:
<https://www.tridonic.com/com/en/software-masterconfigurator.asp>

 4service NFC app:
Smartphone with NFC
4service NFC app is available via the corresponding app store.
Additional information: https://www.tridonic.com/com/en/download/brochures/Leaflet_companionSUITE_EN.pdf

Icon	Function	NFC	DALI-2	ready2mains	U6Me2
	OEM Identification	 	 		-
	OEM GTIN	 	 		-
	LED current	 	 		-
	Device operating mode	 -	 		-
	chronoSTEP	 	 		
	External temperature management (ETM + NTC)	 -	 		-
	Enhanced constant light output (eCLO)	 -	 		-
	DC level	 -	 		-
	Enhanced power on level (ePOL)	 -	 		-
	Intelligent temperature guard (ITG)	 -	 		-
	DALI default parameters	 -	 	-	-
	Scenes and groups	 -	 	-	-
	Customer memory bank	 -	 -	-	-
	Energy reports	 -	 -	-	-
	Diagnostic and monitoring	 -	 -	-	-
	pDALI integrated DALI bus voltage	 -	 -	-	-
	AUX power supply 24 V	 -	 -	-	-
	sensorMODE	 -	 	-	-
	deviceKEY	 -	 	-	-

6.1 LED current



The LED output current must be adapted to the connected LED module. The value is limited by the current range of the respective device.

The priority for current adjustment methods is NFC / DALI (highest priority) and ready2mains (lowest priority).

6.2 chronoSTEP3 (Virtual Midnight)



In the outdoor lighting and street lighting sector it often makes sense to dim the lighting level during night hours in order to save energy.

The chronoSTEP function is a tool that makes this easy to do.

The device automatically measures the switch-on and switch-off times of the lighting installation over the past three days.

The switch-on and switch-off times are typically the times at which the sun sets and rises. The midpoint of these two reference points is the time referred to as Virtual Midnight. The overall time interval between switch-on and switch-off points is called On Time.

Notice

By default, no profile is predefined.

Profile can be programmed by the customer.

When calculating the On Time, only values between 4 and 24 hours are counted. Values less than 4 hours could indicate a power failure and are therefore not saved. For settings longer than 24 hours, 24 hours is saved as the maximum possible value.

chronoSTEP3 supports now fade time.

The fade time can be set individually and is used each time the dimming level changes.

Also virtual midnight can be shifted to cover the case with different time zones in the range of ± 127 minutes.

6.3 External temperature management (ETM + NTC)



ETM protects the LED module against thermal overstress.

An external temperature sensor (NTC) detects the LED module temperature and the LED Driver will limit the output current according to this temperature:

If the temperature is between the limits T1 (normal condition) and T2 (overload), the LED output current will be decreased.

If the temperature exceeds the limit T3 (critical temperature), the device will switch to the shutdown level.

The shutdown level will be active until the module temperature decreases below T1 or until the LED Driver is restarted (switch off or mains reset).



The LED module's temperature is only measured if the output is active (lamp is on).

The allowed NTC resistor value is between 0 to 2 M Ω .

By default there are three predefined values that can be set via programming software, up to five individual values can be added.

6.4 Enhanced Constant Light Output (eCLO)



With this function the light output of the LED module can be kept equal over the life-time.

The light output of an LED module reduces over the course of its lifetime.

The Constant Light Output (eCLO) function compensates for this natural decline by constantly increasing the output current of the LED Driver throughout its lifetime.

Enhanced eCLO shall be achieved by limitation of the LED current at the commissioning of the LED Driver and providing a linear interpolation of the current over the time, depending on the data points given by the user. The user has to insert up to eight pairs of data (time, level). The output curve is the result of connecting the user data points linear. Detailed description for eCLO see product manual.

6.5 Light level in DC operation



In emergency light systems with a central battery supply the DC recognition function uses the input voltage to detect if emergency mode is present.

The LED Driver then automatically switches to DC mode and dims the light to the defined DC level.

Without DC recognition different and more complex solutions would have to be applied in order to detect emergency mode.

DC recognition is integrated in the device as standard.

No additional commissioning is necessary for activation.



This is a safety-relevant parameter.

The setting is relevant for the dimensioning of the central battery system.

The LED Driver is designed to operate on DC voltage and pulsed DC voltage. For a reliable operation, make sure that also in DC emergency operation the LED Driver is run within the specified conditions as stated in chapter "4.1 operating window".

Light output level in DC operation: programmable 1 – 100 %
(factory default = 15 %, EOF_i = 0.13).

The voltage-dependent input current of Driver incl. LED module is depending on the used load.

The voltage-dependent no-load current of Driver (without or defect LED module) is for:

AC: < 41 mA

DC: < 3 mA

In DC operation dimming mode can be activated.

If Dimming on DC is activated the requirements of the DC recognition function are ignored.

Even if DC is detected, the LED Driver continues to behave as in AC mode

- The present dimming level is retained
- An emergency light level defined for the DC recognition function (DC level) is ignored
- Control signals via DALI continue to be executed

If Dimming on DC is activated then emergency mode is not recognised. The device no longer automatically switches to the emergency light level.

6.6 Intelligent Temperature Guard (ITG)



The intelligent temperature guard protects the LED Driver from thermal overheating by reducing the output power or switching off in case of operation above the thermal limits of the luminaire or ballast. Depending on the luminaire design, the ITG operates at about 5 to 10 °C above t_c temperature.

If temperature threshold values are exceeded, the LED output current is limited. These limits can be adjusted using the programming software. Even the current ITG temperature in the device can be read out. With this function, the sensitivity of the temperature control can be adjusted.

6.7 Power-up fading



The power-up function offers the opportunity to modify the on behavior. The time for fading on can be adjusted in a range of 0.2 to 16 seconds. According to this value, the device dims either from 0 % up to the power-on level. By factory default no fading time is set (= 0 seconds).

6.8 Memory bank 1 extension



This function complies to DiiA specification DALI Part 251 - Memory bank 1 extension. It provides an extension to memory bank 1 to enable asset management functionality. Several internal values from the driver could be read out from this memory bank. For example luminaire year, week and description. Also power levels, AC mains voltages and light output can be read out.

6.9 Energy reporting



This function complies to DiiA specification DALI Part 252 - Energy reporting. It provides the information related to energy reporting accessible through memory banks in this driver. Several functions and values could be read out to gain access in Content management systems. Report and values for Active power, Active Energy and many more can be read out.

6.10 Diagnostics and maintenance



This function complies to DiiA specification DALI Part 253 - Diagnostics and maintenance. It provides the information related to diagnostics and maintenance information accessible through memory banks. Several functions and values could be read out to gain access in Content management systems. Report and values for failure behaviour, driver conditions and malfunctions trigger points can be read out.

6.11 Integrated DALI bus power supply



This function complies to DiiA specification DALI Part 250 - Integrated bus power supply. The output power of the integrated DALI bus power supply (pDALI) has an output current of 50 mA. It is activated by factory default for outdoor devices. Sensors and also external drivers could be directly connected to this power supply. The DALI power supply could be deactivated via software.



Several power supply must not be combined.

If the DALI power supply is activated, the driver must not be integrated into an existing, already powered, DALI network.

6.12 AUX power supply



This function complies to DiiA Specification DALI Part 150 - AUX power supply. An auxiliary (AUX) supply provides 24 V DC to power e.g. a controller, an occupancy sensor, a photo sensor or other device. It eliminates the need of an AC/DC supply and the associated need of surge suppression and an EMI filter in such devices.

AUX supply specification:

Average power of 3 W.

Average output voltage of 24 V \pm 10 %

Maximum voltage does not exceed 30 V under any load condition including open circuit.

Start-up time: 90 % of the nominal specified voltage level within 600 ms after applying mains power.

Start-up: After power-on, the load must limit the current consumption at the AUX terminals to at most 160 mA until the specified voltage is reached.

6.13 sensorMODE



The sensorMODE combines the features chronoSTEP and corridorFUNCTION and adds the possibility to control them with a DALI input device directly connected to the LED Driver.

There are different control modes supported by the sensorMODE function:

- Ambient light control
- Motion control
- Ambient light with motion control
- Mains with motion control

6.14 deviceKEY



This function enables a password protection for device settings to prevent unauthorized access or changes.

7. Protective features

7.1 Overtemperature protection

The LED Driver is protected against temporary thermal overheating. If the temperature limit is exceeded the output current of the LED module(s) is reduced. The temperature protection is activated above $t_{c\ max}$. The activation temperature differs depending on the LED load. On DC operation this function is deactivated to fulfill emergency requirements.

7.2 Short-circuit behaviour

In case of a short-circuit at the LED output the LED output is switched off. After restart of the LED Driver the output will be activated again. The restart can either be done via mains reset or via interface (DALI, ready2mains).

7.3 No-load operation

The LED Driver will not be damaged in no-load operation. The output will be deactivated and is therefore free of voltage. If a LED load is connected, the device has to be restarted before the output will be activated again.

7.4 Overload protection

If the output voltage range is exceeded, the LED Driver turns off the LED output. After restart of the LED Driver the output will be activated again. The restart can either be done via mains reset or via interface (DALI, ready2mains).

7.5 IVG+ – Intelligent Voltage Guard Plus



In some cases mains voltage is not stabilized and has some voltage peaks which are lower or higher than the nominal voltage range. Between 192 V and 80 V input voltage, the LED Driver operates in under-voltage mode and dims the secondary side linearly down to 10 %. Below 80 V input voltage, the LED Driver shuts down, restarts at 90 V (without a reset) and dims linearly up back to 100 %. Above 280 V input voltage, the LED Driver shuts down. If input voltage drops below 270 V, the LED Driver restarts (without a reset).

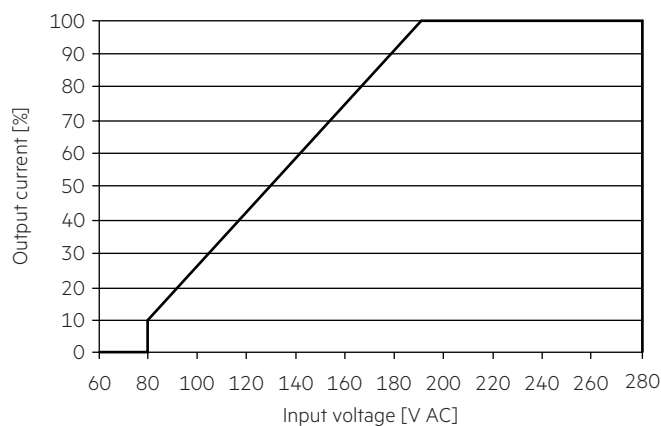

7.6 Insulation between terminals

Insulation	Mains	PE	NTC / LED	AUX / DALI
Mains	–	double	double	double
PE	double	–	basic	basic
NTC / LED	double	basic	–	basic
AUX / DALI	double	basic	basic	–

basic ... represents basic insulation.

double ... represents double or reinforced insulation.

8. Miscellaneous

8.1 Insulation and electric strength testing of luminaires

Electronic devices can be damaged by high voltage. This has to be considered during the routine testing of the luminaires in production.

According to IEC 60598-1 Annex Q (informative only!) or ENEC 303-Annex A, each luminaire should be submitted to an insulation test with 550 V_{DC} for 1 second. This test voltage should be connected between the interconnected phase and neutral terminals and the earth terminal. The insulation resistance must be at least 2 MΩ.

As an alternative, IEC 60598-1 Annex Q describes a test of the electrical strength with 1550 V_{AC} (or 1.414 x 1550 V_{DC}). To avoid damage to the electronic devices this test must not be conducted.

The equipotential terminal is used to connect the heat sink and the LED Driver to reduce transients.

8.2 Conditions of use and storage

Humidity: 5 % up to max. 90 %, not condensed (max. 56 days/year at 90 %)

Storage temperature: -40 °C up to max. +80 °C

The devices have to be acclimatised to the specified temperature range (ta) before they can be operated.

8.3 Maximum number of switching cycles

All LED Driver are tested with 50,000 switching cycles. The actually achieved number of switching cycles is significantly higher.

8.4 Additional information

Additional technical information at www.tridonic.com → Technical Data

Guarantee conditions at www.tridonic.com → Services

Life-time declarations are informative and represent no warranty claim. No warranty if device was opened.